

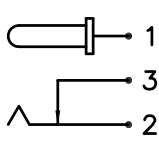

SCHEMATIC	
MODEL NO	C

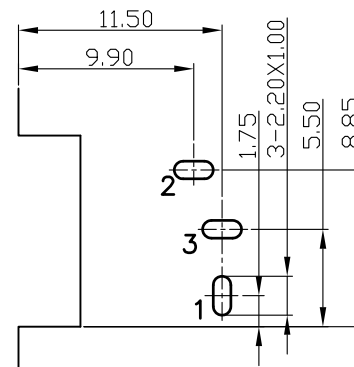
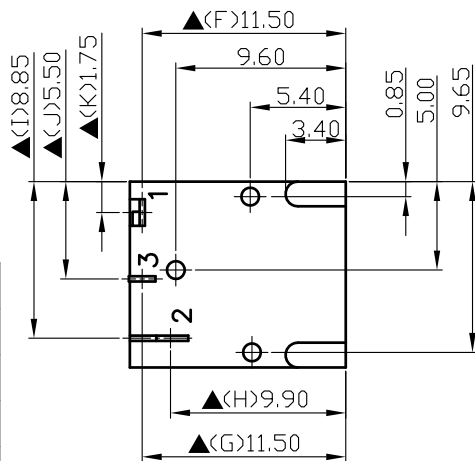
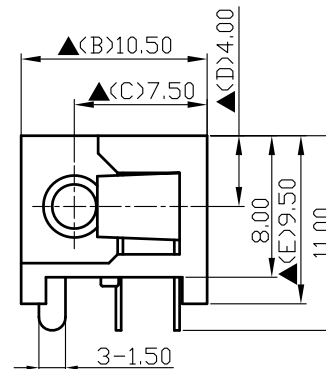
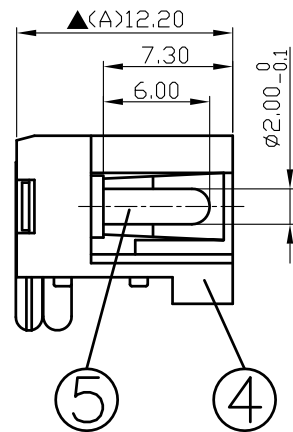
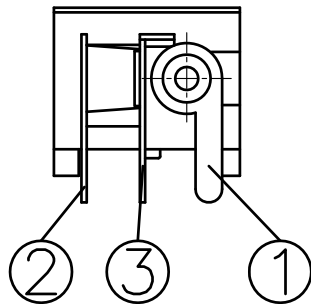

Pin Hole Layout  
(Jack Bottom View)

5.	Pin(2.0 $\phi$ )	Copper	1	Nickel Plated
4.	Housing	PBT+30%	1	Black color
3.	Break Terminal	0.4T Brass	1	Silver Plated
2.	Sleeve Spring	0.3T Phosphor Bronze	1	Silver Plated
1.	Pin Terminal	0.3T Brass	1	Silver Plated
NO.	Description	Material	Q'TY	Finish

 <b>S.C.PRECISION INDUSTRIAL CO., LTD.</b>	DATE	DWN	CHKD	APVD	MANAGER
	10.06.2021	王平華			

PART NAME :DC POWER JACK	PART NUMBER:SCD451CCS000B00G	VERSION:9.0
TOLERANCE : $\pm 0.3$ mm UNLESS OTHERWISE SPECIFIED	UNIT:mm 	SCALE:1/1

SPECIFICATIONS:  
 Contact Resistance : 30m $\Omega$  max  
 Current Rating : Max 5.0A , 24V DC  
 Insulation Resistance : 100M $\Omega$  min. at DC 500V  
 Dielectric Withstanding Voltage: AC 500V for one minute  
 Remark:  $\blacktriangle$  : The Most Important Dimension

For Redference  
僅供參考

RoHS&SVHC  
Compliant